

Protecta-Line Installer Guide



Protecta-Line system overview **7**

**Installation procedures for
Protecta-Line fittings**

Installation of electrofusion and butt-fusion fittings	10
Using Protecta-Line surprep	15
Installation of mechanical fittings	25
Installation of mechanical compression fittings	33
Installation of ferrule off-takes	37

Enabling products, connection to other systems and commissioning **51**

Protecta-Line product range **54**

Pipe	56
Mechanical compression fittings	59
Electrofusion fittings	62
Fabricated fittings and wrapping accessories	66
Mechanical fittings	73
Ferrule off-takes	78
Protecta-Line boundary box	80

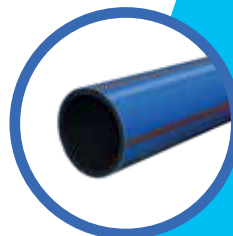

Tel: + 44 (0) 330 111 4233
Email: orders@alixis.co.uk
Web: alixis.co.uk/Protecta-Line



The original, tried and trusted barrier pipe system

Protecta-Line is the original barrier pipe system that you can trust to safely transport drinking water through contaminated land. It has been tried and tested by water companies and housebuilders for more than 25 years.

Over that time it has been proven to maintain the long term safety of supply and keep water safe from surrounding contaminants.

There is no other system that has been developed hand-in-hand with contractors and installers over such a long term. The present day system has attained the highest standards of quality approval and represents a comprehensive barrier pipe solution, incorporating a full range of dedicated and approved fittings. Put simply, why would you risk using anything else?

Protecta-Line benefits

- Provides proven protection against all recognised brownfield contaminants, both organic and inorganic, even in their maximum reported concentrations
- Is suitable for corrosive conditions
- Ensures peace of mind. As a proven solution for more than 25 years, water companies and other installers can be confident in its performance
- Includes a fully integrated range of pipe and approved dedicated fittings
- May be used for trenchless installations or subjected to cold bending



Protection against all known contaminants



No expensive soil samples



Flexible material properties



Save on landfill costs



Excellent lifetime cost savings



Cost savings during installation



Kitemarked system

Safe, effective and proven to protect

Protecta-Line's double bonded five-layer construction consists of an internal standard PE host pipe (PE80 or PE100 conforming to BS EN 12201) for carrying water, an impermeable aluminium barrier layer to stop the ingress of contaminants, an outer polyethylene protection layer and two adhesive tie-layers.

This means Protecta-Line (Kitemarked to BS 8588) is impervious to contaminants in the soil, which means no soil samples or excavation of contaminated soil to landfill are required, delivering lower installation costs.

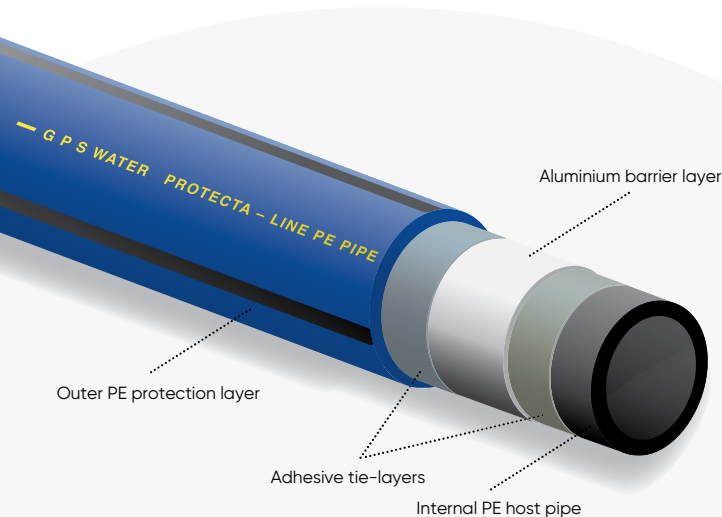

Product range overview

The approved Protecta-Line pipe range is from 25mm to 630mm diameter with working pressures up to 16 bar. It is a complete, approved system, used with confidence by installers for more than 25 years.

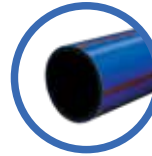

Protecta-Line pipe

PE barrier pipe for water distribution through contaminated land.

Standards/approval: BS 8588, WRAS, Regulation 31/33, BS EN 12201 (core pipes)

Material: Polyethylene Aluminium

Size range: 25mm – 630mm (SDR11) and 90mm – 630mm (SDR17)

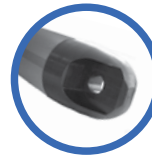

Protecta-Line 3rd & 3rd coils

Clean, capped and coiled PE barrier pipe for installation without pre-chlorination.

Standards/approval: BS 8588, WRAS, Regulation 31/33, BS EN 12201 (core pipes)

Material: Polyethylene Aluminium

Size range: 63mm – 180mm



Mechanical compression fittings

Mechanical compression fittings for service connections.

Standards/approval: BS 8588, WRAS

Material: Acetal

Size range: 25mm – 63mm



Ferrule off-takes

Ferrules for live off-takes with minimal flow restrictions.

Standards/approval: BS 8588, WRAS

Material: Stainless steel, Acetal & Gunmetal

Size range: 25mm & 32mm (for 63mm – 355mm mains), 63mm (for 90mm – 355mm mains)



Protecta-Line Boundary box

For contaminated land to complete the Protecta-Line water supply solution

Standards/approval: BS 8588, WRAS

Material: Polypropylene, Polyethylene, Aluminum, Acetal & uPVC

Lid range: Standard, Slope, Square and Surface box



Mechanical fittings

Mechanical fittings for mechanical jointing without the need for pipe preparation or welding.

Standards/approval: BS 8588, WRAS

Material: Stainless steel, Rilsan coated steel

Size range: 63mm – 180mm



Electrofusion fittings

Electrofusion fittings with a bar coding system for rapid and convenient jointing.

Standards/approval: BS 8588, WRAS

Material: Polyethylene

Size range: 90mm – 630mm



Pupped fittings

Extended spigots suitable for electrofusion and butt-fusion jointing

Standards/approval: BS 8588, WRAS (pipes and spigots)

Material: Polyethylene

Size range: 90mm – 630mm

Applications

- Drinking water distribution in contaminated land (brownfield sites where land or premises that have previously been used or developed. They may also be vacant, or derelict)
- Drinking water distribution in sites with potential future contamination issues (e.g. new petrol station forecourts)

NOTE: Only Protecta-Line fittings can be used with Protecta-Line pipe and vice versa. The use of alternative fittings will have the following effects on your Protecta-Line system:

- Invalidation of WRAS approval and manufacturer's system performance warranty
- Compromised permeation resistance (causing non-compliance with BS 8588 and possible risks to health)
- Danger of pipe-layer delamination, compromising system performance integrity and risking pipe bursts
- It is illegal to install fittings non-compliant with the water fittings regulations (or byelaws in Scotland)
- Product mismatch leading to product damage

Installation procedures for electrofusion fittings and butt-fusion

When made in accordance with our recommended procedures, butt-fusion and electrofusion joints of the Protecta-Line system have been independently shown to meet the requirements of BS 8588 without any need for subsequent wrapping. This does not exempt installers from local regulations and the local water company preferences must be adhered to. Standard electrofusion procedures must be adhered to, but note the following additional points:

Electrofusion

It is essential that the Protecta-Line pipe is properly prepared prior to electrofusion jointing. It is necessary first to remove the outer PE layer, aluminium layer and any residual adhesive layer material. The Protecta-Line surprep scraper must be used for pipe end preparation, as it not only removes the outer layers, but it also prepares the core pipe for electrofusion jointing. If the electrofusion process is conducted on a section that contains elements of aluminium or adhesive then this will cause an insufficient weld on those areas and cause the fitting to fail prematurely.

Alignment clamps should be checked for suitability before commencing work, particularly in larger sizes. All electrofusion joint assemblies must be held in clamps throughout the fusion and cooling periods.

Protecta-Line jointing end preparation for electrofusion procedures

Size	Length	Min preparation/depth Insertion depth	Max preparation depth
90	157	77	82
110	159	78	83
125	172	84.5	89.5
160	190	93.5	98.5
180	210	103.5	108.5
225	236	114	119
250	220	111	116
280	220	109	114
315	300	137	142
355	300	146	151

For diameters above 355mm, please contact Aliaxis technical advice on +44 (0) 330 111 4233, option 2, or technical.advice@alixis.com

Squeezing off

Protecta-Line pipe can be squeezed off in the industry approved way. However, as a precaution after re-rounding, previously squeezed off areas should be wrapped with Protecta-Line aluminium tape followed by a proprietary waterproof petrolatum (silicone) tape, in addition to any reinforcement bands that may be required to be fitted.

Butt-fusion

Where this is permitted by the local water company, it is important that the outer PE and aluminium layers are removed far enough back, using the Protecta-Line surprep tool (see pages 15-24), to prevent the aluminium from coming into contact with the butt-fusion machine trimmer or heater plates.

In addition, the outer PE and aluminium layers should be removed far enough back to permit normal debanding of the completed joint for normal quality control purposes.

It is recommended that the layers should be removed to a length equal to the width of the debanding tool on the end of each pipe.

Butt fusion clamps should be checked for suitability before commencing work, particularly in larger sizes. Care should be taken not to damage the outer layers of Protecta-Line pipe when clamping it in the butt-fusion machine. In the case of some machines this may necessitate gently radiusing the edges of the jaw shutlines.



Wrapping

When made in accordance with our recommended procedures, butt-fusion and electrofusion joints of the Protecta-Line system have been independently shown to meet the requirements of BS 8588 without any need for

subsequent wrapping. This does not exempt installers from local regulations and the local water company preferences must be adhered to.

Should wrapping be required, the following table and procedure can be used for guidance.

Aluminium foil wrapping lengths

Size (mm)	EF fitting length (mm)	Amount of foil required (m)	Joints per roll (foil)	Amount of silicone tape required (m)	Joints per roll (silicone)
90	157	2.2	20.0	2.3	4.7
110	159	2.7	16.4	2.9	3.8
125	172	3.4	13.3	3.5	3.1
160	190	4.8	9.5	4.9	2.2
180	210	5.8	7.8	6.0	1.8
200	220	6.8	6.6	7.1	1.5
225	236	8.2	5.5	8.6	1.3
250	246	9.7	4.6	10.1	1.1
280	285	12.4	3.6	12.9	0.8
315	300	14.7	3.1	15.3	0.7
355	300	16.8	2.7	17.5	0.6
400	320	20.1	2.2	20.9	0.5
450	340	23.9	1.9	24.9	0.4
500	360	28.5	1.6	29.7	0.4
560	380	34.1	1.3	35.6	0.3
630	420	42.8	1.1	44.5	0.2

Aluminium wrapping tape (45m long x 50mm wide): 44996008
Silicone tape (10.9m long x 48mm wide): 53996001

Procedure for wrapping butt-fusion and electrofusion joints (if required by local water authority)

1. Following the jointing of Protecta-Line pipe with electrofusion fittings or butt-welding, the complete joint area should be wrapped with Protecta-Line adhesive aluminium tape.

Having completed the electrofusion process the terminals and shrouds may be cut off to facilitate ease of wrapping.

2. After completing the jointing procedure, the whole assembly should be dry and clean. Care should be taken to ensure that when wrapping joints with the adhesive aluminium foil the extremities of the joint are wrapped using a 100% overlap and the main body area with a 50% overlap.
3. Additional protection can be afforded by further wrapping the now aluminium wrapped joint area followed by a proprietary waterproof petrolatum or silicone tape. (Specific product advice should be requested if products other than those referenced are to be used).

Procedures for using Protecta-Line surprep scraper

NOTE: The barrelling effect (end reversion) found at the end of the pipe may result in the barrier layers remaining on the pipe surface for a short distance from the end of the pipe.

Using the surprep scraper (90mm-180mm)



The Protecta-Line surprep kit has been designed to allow the correct scraping of Protecta-Line barrier pipe prior to electrofusion jointing.

1. Measure the insertion depth of the electrofusion fitting to be used. Place a mark on both pipes to show the position where the edge of the fitting will be.

2. Clamp the pipe to be prepared, taking care to avoid damage to the pipe's outer covering.
3. Separate the mandrel from the body of the Protecta-Line surprep scraper.
4. Hold the expanding collet and rotate the



mandrel anticlockwise until the collet is a light interference fit in the pipe bore.

5. Push into pipe until edge of collet is level with edge of pipe. Expand collet further using the 10mm ring spanner. Do not over-tighten in order to avoid pipe distortion.



6. Slide the body of the Protecta-Line surprep scraper onto the mandrel, depress the release button and position the cutter close to the edge of the pipe.

NOTE: Protecta-Line surprep scraper cuts in an anti-clockwise direction, beginning at the end of the pipe.

7. Rotate the knob on the top of the tool post through 90°, against the spring tension, such that the cutter is in its raised position.
8. Loosen the body thumbscrew and position the cutter shoe on the edge of the pipe. Tighten the thumbscrew.



9. Rotate the knob on top of the post through 90° so that spring pressure is applied to the cutter.

10. Rotate the tool anti-clockwise in a smooth continuous motion to remove the outer layers in a continuous strip.
11. Stop cutting when the socket depth mark is reached.

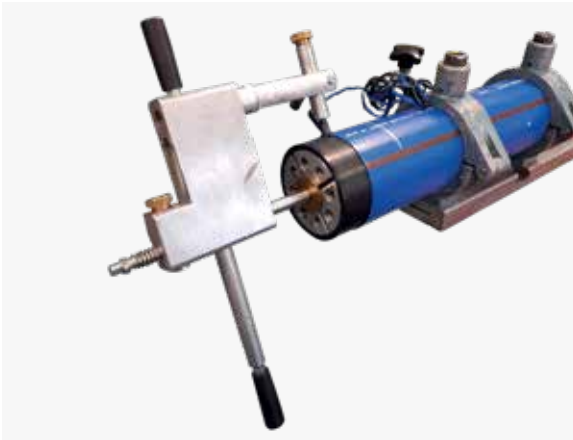

12. Rotate the knob on top of the tool post so that the spring pressure is released.
13. Use the hand scraper to remove the peeled strip from the pipe.

Caution: Do not attempt to break the peeled strip by pulling with bare hands, it has a sharp edge! Remove the tool in the reverse order of assembly (steps 3-6).

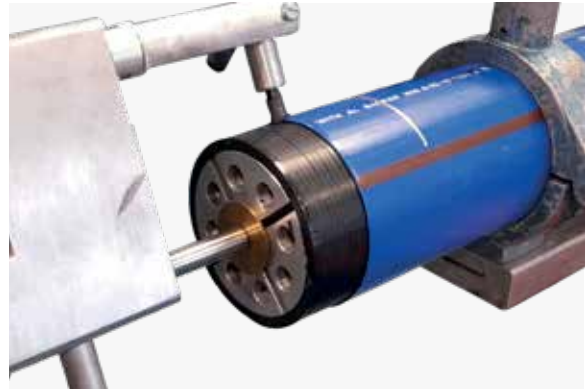

14. Inspect the prepared surface to ensure:
 - i) All of the metallic layer has been removed.
 - ii) All of the adhesive which bonds the metallic layer to the core has been removed.
15. If, for any reason, the prepared surface is not a uniform colour all over, use the hand scraper to complete the preparation process

NOTE: Never attempt a second pass with the Protecta-Line surprep scraper.

Using the large diameter surprep scraper (above 180mm)

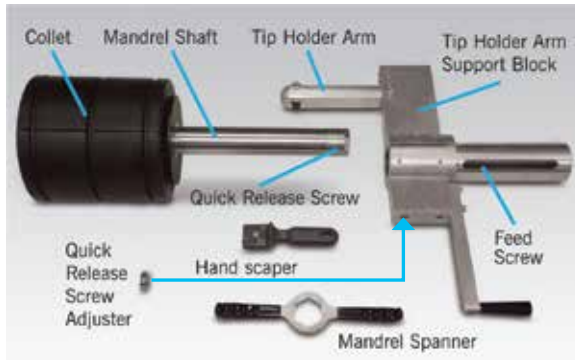

For Protecta-Line sizes above 180mm, the surprep scraper is a dedicated tool for each pipe size, with the cutter set to produce the required outside diameter. **Adjustments must be carried out by a competent person and can only be done on site as each pipe batch requires repeated scraper calibration.**



1. First mark the required length of pipe to be scraped (see table on page 11). Ensure that the correct size collet for the pipe to be scraped is fitted to the mandrel. Adjust the collet by twisting the mandrel shaft anti-clockwise until it achieves its smallest outside diameter.

Slide the collet into the bore of the pipe, allowing 20mm of pipe to show after the collet, to allow for the barrelling effect found at the end of the pipe.



2. Adjust the collet by twisting the mandrel shaft clockwise until the mandrel becomes secure in the bore of the pipe and tighten with the mandrel spanner. To achieve the correct alignment parallel to the pipe bore, a joggling action in all directions is required. The collet also acts to re-round the pipe so check for gaps between the collet and the bore of the pipe.



3. Once the mandrel is secure and is parallel with the pipe bore, screw down the quick release screw to its full extent (about one and a half turns) using the adjuster, which is stored at the base of the tip arm support block.

NOTE: Remember the position of the quick release screw.

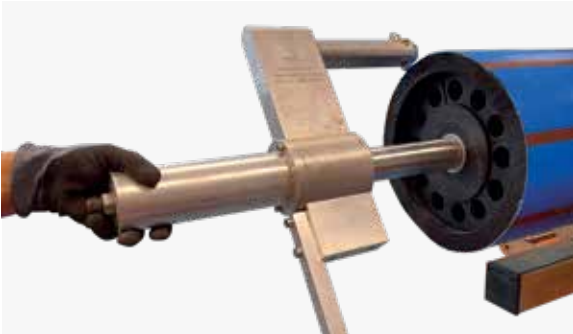

4. Ensure that the tip holder arm has been located in the hole corresponding to the pipe size in the tip holder support block. Locate the tool onto the mandrel shaft taking care not to damage the bore of the tool. Slowly slide the tool along the mandrel shaft using a twisting action, until the feed screw touches the quick release feed screw nut.

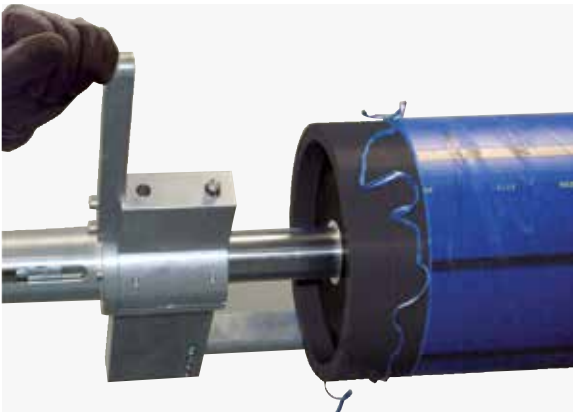

5. Taking care to avoid damaging the quick release nut and feed screw, rotate the tool in a clockwise direction with a slight force pushing forward. Once the feed screw has engaged with the quick release nut, it will now proceed to travel along the length of the mandrel shaft, removing the outer barrier layers and preparing the pipe for electrofusion jointing.



6. When the required length of pipe has been prepared, raise the quick release screw to its top position (about one and a half turns). The quick release screw can be accessed through the slot in the feed screw housing tube.



7. The tool can now be removed from the mandrel shaft.

NOTE: The tool should be removed to a clean dry and safe area.



8. Loosen the collet using the mandrel spanner on the mandrel shaft in an anti-clockwise direction until free.



9. Remove the collet and mandrel from the pipe. The collet should be removed to a clean dry and safe area. If there are any areas of pipe that have not been prepared properly, then the hand scraper should be used to complete the preparation process.

Installation procedure for Protecta-Line mechanical fittings

- These fittings are designed for use on Protecta-Line pipes only and their performance on other piping systems is not approved or guaranteed.
- Gloves and safety glasses must be worn during the whole assembly process.
- A torque wrench is required with a 10mm allen (hex) socket for sizes 63mm - 125mm and a 14mm allen (hex) socket for 160mm - 180mm fittings.

1. **DO** ensure that the pipe ends are cut square.
2. **DO** ensure that the pipe is correctly aligned onto the fitting spigot.
3. **DO** ensure that the pipe is butted up to the insert spigot's pipe stop.
4. **DO** ensure that the shell is flush with the pipe end on the spigot.
5. **DO** remember to re-torque the bolts.
6. **DON'T** remove the fitting and try to reinstall on the same section of pipe, this may create a leak path due to the grooves previously formed on the pipe bore.

1. Ensure the pipe ends are cut square. With the insert in place in the pipes to be joined, or, with a 5mm gap between them, centre the shells over the pipe ends and mark the penetration depth.



2. Slide the shell over one of the pipe ends to be joined.



3. Push the insert into the pipe end.



4. Offer up the second pipe end onto the insert and push the pipes together, ensuring both pipes are up against the pipe stops of the insert and correctly aligned on the pipe.



5. Ensure the shells are flush with the pipe ends or for the straight coupler, centre the shell between the depth penetration marks. The fitting is ready to be tightened. Set the torque wrench to the value indicated on the label of the shell.



6. Tighten the hex socket head bolts until the set torque is achieved in each bolt. For the straight couplers, which have two bolts on a double width shell, tighten the bolts alternately and evenly until set torque is achieved in each bolt. The pipe will relax after the set torque is achieved, so after a minute or more, retighten the bolts to the set torque. Repeat until less than a quarter turn is needed to reach the set torque*.

* Repeated tightening of the bolts up to the set torque is necessary and important to compensate for relaxation in the polyethylene. It's normal for the re-torquing process to be conducted three to four times over the course of 5 minutes, but a longer allowance for relaxation between re-torquing may be needed in extremely cold weather where 10 to 15 minutes may be needed for the complete installation process.

Repair section using Protecta-Line mechanical repair couplers

- These fittings are designed for use on Protecta-Line pipes only and their performance on other piping systems is not approved or guaranteed.
- Gloves and safety glasses must be worn during the whole assembly process.
- A torque wrench is required: with a 10mm allen (hex) socket for sizes 63mm - 125mm and a 14mm allen (hex) socket for 160mm - 180mm fittings.

1. Cut out the damaged pipe section. The minimum length of the cut is shown in the table below.

Pipe Size (mm)	Minimum Cut Out Length (mm)	Length of the Repair Piece (mm)
63	440	240
90	440	240
110	470	270
125	470	270
160	470	270
180	470	270

2. From an undamaged pipe length cut out a repair piece. The length of the repair piece should be equal to the length of the cut out less 200mm.



3. Fit the half shells to the ends of the cut out section and mark the penetration depths.



4. The penetration depth is shown in the table on page 32.

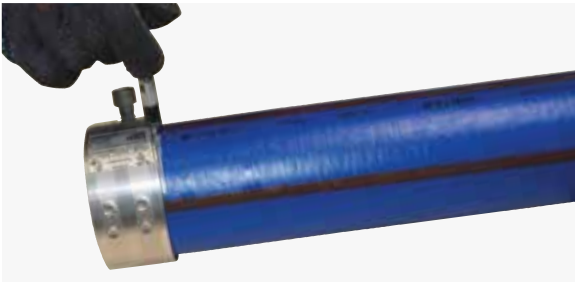

5. Push the repair coupler inserts into the repair piece and position into the cut section.



6. Slide the repair coupler inserts into the cut pipe ends, so all of the depth marks are visible.



7. Tighten the hex socket head bolts until the set torque is achieved in each bolt. The pipe will relax after the set torque is achieved, so after a minute or more, retighten the bolts to the set torque. Repeat until less than a quarter turn is needed to reach the set torque.*



Nominal Pipe Size (mm)	Insertion depth (mm)	Bolt Hexagon (mm)	Torque Nm
63	45	10	60
90	45	10	60
110	52.5	10	60
125	52.5	10	60
160	52.5	14	160
180	52.5	14	160

* Repeated tightening of the bolts up to the set torque is necessary and important to compensate for relaxation in the polyethylene. It's normal for the re-torquing process to be conducted three to four times over the course of 5 minutes, but a longer allowance for relaxation between re-torquing may be needed in extremely cold weather where 10 to 15 minutes may be needed for the complete installation process.

Installation instructions for Protecta-Line mechanical compression fittings

Mechanical jointings allow Protecta-Line to be installed and joined in all weather conditions without requirement for specialist equipment. In addition, the mechanical method is suitable for joining polyethylene to many other materials.

1. Cut the pipe square. Unscrew the Protecta-Line fitting and remove the nut and white split ring. Slide these on to the Protecta-Line pipe, first ensuring that the taper of the split ring faces towards the nut.



2. Tap the insert into the end of the Protecta-Line pipe with a flat wooden object. Ensure that the seal ring is correctly positioned on the pipe insert.

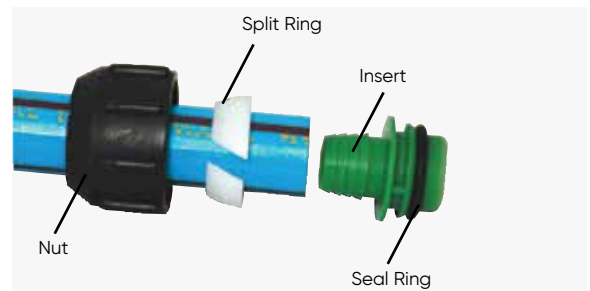

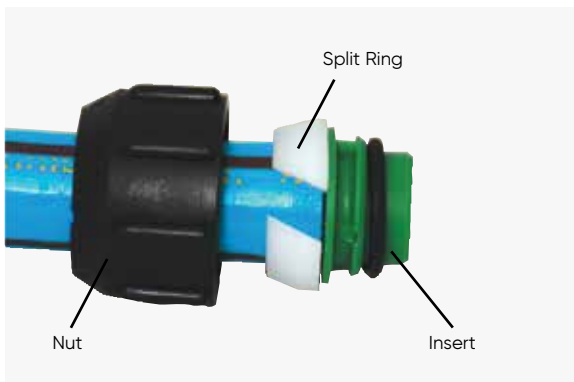

3. Slide the split ring along the Protecta-Line pipe until it is up against the insert. Snap the nut over the split ring.



4. Offer the body of the fitting to the Protecta-Line pipe end and screw the nut on to the fitting body. Continue to tighten the nut until the thread on the body is no longer visible using a C spanner. We recommend our 50-110mm C spanner (Product code: 90705000)

Protecta-Line to copper joint (incorporates insert set for Copper Type A for above ground use on Table X tube)

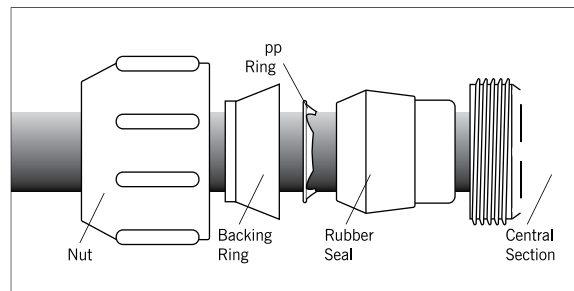

1. Cut copper pipe square, preferably with cutters, and deburr.
2. Degrease pipe and roughen with wire wool or similar.
3. Unscrew nut from copper side of Protecta-Line fitting and slide this nut and plastic backing ring along copper pipe - with taper of backing ring towards nut.
4. Then, slide metal gripper ring on to pipe and position it 10-15mm from end, ensuring flat face of gripper ring is facing towards backing ring/nut (i.e. slots in the gripper ring must face towards fitting body).
5. Next, slide rubber seal onto copper pipe all the way up to internal stop - taper facing towards other parts already on pipe.
6. This will make certain that the metal gripper ring is pushed to correct location along pipe.
7. Slide backing ring forward to meet gripper ring/rubber seal.

8. Push assembly into body of Protecta-Line fitting and engage nut.
9. Tighten nut firmly with a wrench.
10. Ensure all pipework is securely anchored to counteract end loading.

Caution: Do not use heat near plastics and do not re-use

Connecting Protecta-Line mechanical compression fittings to iron fittings

When screwing Protecta-Line mechanical compression fittings onto iron fittings it is important not to use excessive amounts of thread sealing tape or other materials as this can result in unreasonable force needed to complete the joint. Thread sealing tape should be WRc approved.

Installation of ferrule off-takes

NOTE: For use on Protecta-Line pipe only.

Joining instruction for Protecta-Line self tapping ferrule off-takes (25mm or 32mm outlet)

- For main sizes 63mm/90mm/110mm/125mm /160mm/180mm SDR17/SDR11
- Gloves and safety glasses must be worn during the whole assembly process. Do not remove cutter or sleeve from this product before use.
- The ferrule strap cutter includes a sealing sleeve that prevents water contact with the aluminium barrier layer.

Tooling required:

- 13mm socket wrench or spanner
 - 8mm or 11mm drill key for 25mm or 32mm outlet
1. Clean the top of the Protecta-Line main where the ferrule strap is to be fitted, avoiding areas which appear damaged. Ensure that the sealing "O" ring is in place under the upper ferrule strap.



- Unhitch the lower part of the ferrule understrap from the tabs on the upper part of the strap. Leaving the bolt in place, fit the ferrule squarely around the main, re-attach the understrap to the appropriate tabs.



- Tighten the strap bolt with a 13mm socket wrench or spanner to 12-14Nm of torque.

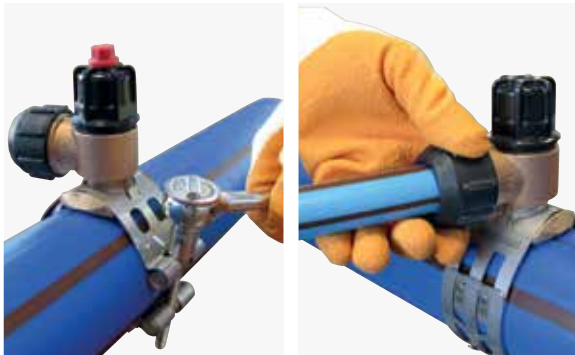

- Fit the Protecta-Line service pipe into the compression fitting on the outlet, as described in the instructions on page 37. After aligning the outlet to the desired position, tighten the securing collar and compression fitting. **Test T and connections prior to drilling.**

- Remove the plug from the top of the ferrule cap, and, using the square section key, wind down the cutter assembly all the way until hard and solid resistance is felt. Note that before the solid resistance is felt there may be a temporary drop in resistance, followed by an increase as the sleeve around the cutter enters the main.



- Withdraw the cutter all the way up to the top of the stem, employing a final counter-clockwise torque of 12-14Nm to ensure a good seal. Some leakage through the plughole is normal before the cutter has been fully unscrewed. Replace the plug.



Jointing instruction for Protecta-Line self tapping ferrule off-takes SDR17 (25mm or 32mm outlet)

- Gloves and safety glasses must be worn during the whole assembly process
- The ferrule cutter includes a sealing sleeve (liner) that prevents water contact with the aluminium barrier layer
- The top of the Protecta-Line main (where the ferrule strap is to be fitted) should be cleaned before installation
- The overlap 'ridge' of the aluminium barrier layer should be avoided when installing the ferrule strap

Contents:



Tooling requirements:

19mm socket wrench or spanner

Torque wrench

8mm/11mm drill key for 25mm/32mm cutter



1. Unscrew body top and outlet banjo ensuring all seals are retained and set aside, which is only applicable on mains 200mm and above. Ensure that the sealing O-ring is in place under the upper ferrule strap (take care not to damage this on the protruding sleeve).



2. Fit strap squarely on main and tighten bolts to a torque 20Nm - 24Nm. Make sure both bolts are tightened evenly.

NB. For main sizes 315mm/355mm, apply a torque of 40Nm-44Nm.

3. Replace outlet banjo with large seal top and bottom. Ensure the cutter is fitted with the liner before installing it in the ferrule body. The cutter shall be turned down, flush with the top of the body before fitting the ferrule cap.

NB. The liner must be installed to stop any water from penetrating the pipe layers. Failure to fit the liner will result in the pipe de-laminating and will invalidate any warranty.



4. Make sure the small seal is placed in the cap. Replace and tighten the cap. Fit the Protecta-Line service pipe into the compression fitting on the outlet, as described in the instructions on page 37. After aligning the outlet to the desired position, tighten the securing collar and compression fitting and test T and connections prior to drilling.



5. Remove the plug from the top of the ferrule cap, and using the drill key, wind down the cutter assembly all the way until hard and solid resistance is felt.



Retract the cutter until it seals fully against the inside top of the body.

NB. You should feel growing resistance before the cutter turns easily and then stops. It is normal to get a slight discharge of water during this operation.

5. Replace the plug on the ferrule cap and commission as normal

Refer to page 37 for Jointing instructions for Protecta-Line mechanical compression fitting outlet.



Protecta-Line self tapping ferrule off-takes with pre-cutter (25mm or 32mm outlet)

- For main size 200mm/225mm/250mm/280mm SDR11, and 315mm/355mm SDR11/SDR17
- Gloves and safety glasses must be worn during the whole assembly process
- The ferrule cutter includes a sealing sleeve (liner) that prevents water contact with the aluminium barrier layer
- The top of the Protecta-Line main (where the ferrule strap is to be fitted) should be cleaned before installation
- The overlap 'ridge' of the aluminium barrier layer should be avoided when installing the ferrule strap

Contents:

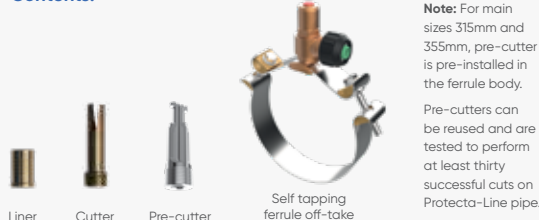

Tooling requirements:

19mm socket wrench or spanner

Torque wrench

8mm/11mm drill key for 25mm/32mm cutter



1. Unscrew body top and outlet banjo ensuring all seals are retained and set aside, which is only applicable on mains 200mm and above. Ensure that the sealing O-ring is in place under the upper ferrule strap (take care not to damage this on the protruding sleeve).

2. Fit strap squarely on main and tighten bolts to a torque 40Nm - 44Nm for main sizes 315mm and 355mm. Make sure to tighten both bolts evenly.



3. Ensure pre-cutter is installed, and replace outlet banjo with large seal top and bottom.



4. Fit the drill key into pre-cutter and turn down until pre-cutter comes to a stop. Once pre-cutter comes to a stop, retract it fully from the ferrule body.



NB. Pre-cutter can only travel part way through the pipe wall.

5. The pre-cutter will remove the swarf generated by the drilling. Check for any additional swarf that hasn't been removed fully before moving onto the next step.



6. Ensure the cutter is fitted with the liner before installing it in the ferrule body. The cutter shall be turned down flush with the top of the body before fitting the ferrule cap. Make sure the small seal is placed correctly in the cap.



NB. The liner must be installed and stops any water from penetrating the pipe layers. Failure to fit the liner will result in the pipe de-laminating and will void the approval.

7. Replace and tighten the cap. Fit the Protecta-Line service pipe into the compression fitting on the outlet, as described in the instructions on page 35. After aligning the outlet to the desired position, tighten the securing collar and compression fitting.



8. Remove the plug from the top of the ferrule cap, and, using the drill key, wind down the cutter assembly all the way until hard and solid resistance is felt. Retract the cutter until it seals fully against the inside top of the body.



NB. You should feel growing resistance before the cutter turns easily and then stops. It is normal to get slight discharge of water during this operation.

9. Replace the plug on the ferrule cap and commission as normal.



Joining instruction for Protecta-Line ferrule off-takes (63mm outlet)

- Gloves and safety glasses must be worn during the whole assembly process
- The top of the Protecta-Line main (where the ferrule strap is to be fitted) should be cleaned before installation
- The overlap 'ridge' of the aluminium barrier layer should be avoided when installing the ferrule strap

Contents:



Tooling requirements:

Tooling requirements:	Code
Protecta-Line SS strap drill head	44 794 008
Protecta-Line SS strap liner insertion head	44 794 009
110V power drill	-
44mm extra depth starrett cutter	-

Important tooling information

Protecta-Line 63mm outlet ferrules with stainless steel straps must be installed with the new and compatible SS strap drill head (part code 44794008) and liner head (part code 44794009).

The last generation of drill head and liner head used with Protecta-Line gunmetal ferrules can be adapted for use with the new stainless steel strap ferrules by fitting a 44mm cutter and liner insert. An adaptor kit is available to order (part code 44794020). For replacement instructions, please contact the Aliaxis Technical Advice team by phone on: 01480 44 2600, option 2, or by email at: technical.advice@alixis.com

1. Ensuring that the O-ring is in place under the ferrule main body, fit the strap squarely around the main in the required position and tighten the 2 bolts evenly to a torque between 20Nm-24Nm for main sizes 200mm - 280mm. Ensure the ball valve operates correctly.



NB: For main sizes 315mm and 355mm, apply a torque of 40Nm - 44Nm.

2. After assembling the drill stem with a 44mm extra deep hole cutter, withdraw the drill stem fully into the drill head.



3. Ensure the ball valve is in the fully open position. Fit the drill head to the outlet of the ferrule.



4. Attach the 110V power drill to the drill stem and apply slight pressure whilst drilling the main until there is no resistance (main wall drilled).

NB: 110V power drill must be used to ensure efficient power. Cordless drill is not recommended.



5. Disconnect power supply and remove drill from stem. Withdraw stem, until the cutter is fully returned into the drill head and fully close the valve (handle is horizontal to valve) before removing the drill head from the outlet of the ferrule.

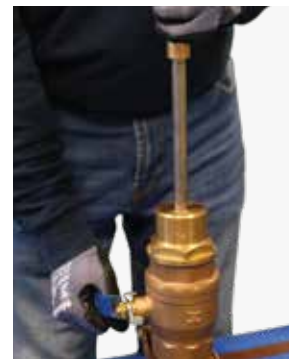

6. Position the liner insert onto the carrier of the liner insertion head. Fully withdraw the liner into the liner insert head.

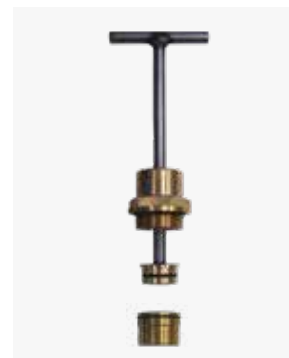

- Fit the liner insertion head to the outlet of the ferrule. Open valve and push the stem down until liner engages with main (may require some additional force to deploy liner fully into main).



- Withdraw the liner insertion head stem until the carrier is fully withdrawn into the liner insert head. Close the ball valve and remove the liner insertion head.



- The communication pipe can now be fitted to the outlet of the ferrule utilising a Protecta-Line 63mm x 2" MI mechanical end connector, either directly to the ferrule outlet (side connection) or in conjunction with a 2" MI/FI 90° elbow (top connection).



Enabling products

Stop cocks (BS 5433 type) are available with integral Protecta-Line mechanical compression couplers in sizes 25mm and 32mm. For larger sizes and as an alternative to the above, stop cocks with threaded connections can be used in conjunction with Protecta-Line mechanical compression end connectors.

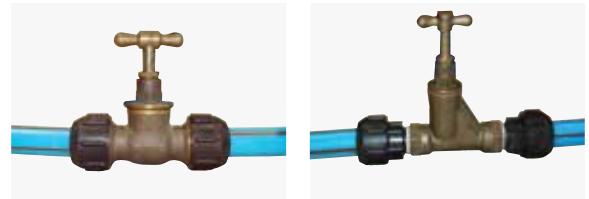

Boundary boxes may be used, provided they are manufactured in accordance with the required standards, listed in the WRAS approved water fittings directory (section 1520 or 1525), and comply with the requirements of WIS 4-37-01. Connecting couplers must be approved for use with the Protecta-Line system and pass the requirements of BS 8588. The pipe inserts of Protecta-Line mechanical compression fittings seal on the pipe bore and isolate the pipe end from any water pressure. The fittings' threads are BSP taper (male or female) and connections should only be made to the equivalent male or female threaded connections of the boundary box. Above ground mounted/built-in meter boxes should be considered when the internal components of a boundary box (manifold and/or meter) are of a polymeric material and there is a risk of contaminant ingress where Protecta-Line pipe feeds straight into the box. Connections to the meter manifold inlet should only be made with fittings approved for use with the Protecta-Line system.

Connecting to alternative barrier pipe systems

To connect Protecta-Line to alternative barrier pipe systems, a mechanical connection should be used: either a threaded connection in the case of the service pipe sizes or a flange connection in the case of larger sizes. Contact our technical advice team for further details.

Capping off

An appropriate Protecta-Line mechanical compression fitting can be used to cap off Protecta-Line pipes as shown below.



Testing and commissioning

The sequence of events for Protecta-Line includes the same basic testing procedures as for conventional PE pipes, but taking extra care appropriate for a contaminated environment as set out by the local water undertaking. Testing and commissions are recommended to follow UK water industry information & guidance notes.

Protecta-Line Product range

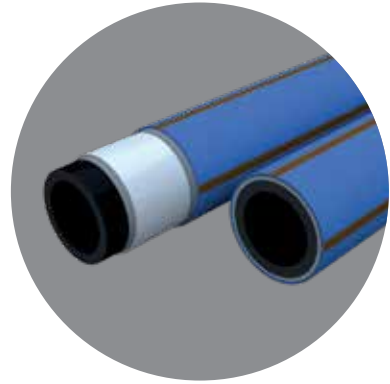

Protecta-Line pipe



STRAIGHT LENGTH

Size	SDR	Pressure Rating (bar)	6M Code	12M Code
63	11	16	44 512 311	-
	11	16	44 512 313	44 527 313
90	17	10	44 653 313	44 654 313
110	11	16	44 512 314	44 527 314
	17	10	44 653 314	44 654 314
125	11	16	44 512 315	44 652 315
	17	10	44 653 315	44 654 315
160	11	16	44 512 317	44 527 317
	17	10	44 653 317	44 654 317
180	11	16	44 512 318	44 652 318
	17	10	44 653 318	44 654 318
225	11	16	44 512 320	44 652 320
	17	10	44 653 320	44 654 320
250	11	16	44 512 321	44 527 321
	17	10	44 653 321	44 654 321
280	11	16	44 512 322	44 527 322
	17	10	44 653 322	44 654 322
315	11	16	44 512 323	44 527 323
	17	10	44 653 323	44 654 323
355	11	16	44 512 324	44 527 324
	17	10	44 653 324	44 654 324
400	11	16	44 512 325	44 527 325
	17	10	44 506 325	44 507 325
450	11	16	44 512 326	44 527 326
	17	10	44 506 326	44 507 326
500	11	16	44 512 327	44 527 327
	17	10	44 506 327	44 507 327
560	11	16	44 512 328	44 527 328
	17	10	44 506 328	44 507 328
630	11	16	44 512 329	44 527 329
	17	10	44 506 329	44 507 329

Protecta-Line pipe



COILS

Size* (mm)	SDR	Pressure Rating (bar)	25M Code	50M Code	100M Code
25	11	12.5	44 658 307	44 659 307	-
32	11	12.5	44 658 308	44 659 308	-
63	11	16	44 658 311	44 659 311	44 660 311
90	11	16	-	44 659 313	44 660 313
	17	10	-	44 655 313	44 656 313
110	11	16	-	44 659 314	44 660 314
	17	10	-	44 655 314	44 656 314
125	11	16	-	44 659 315	44 660 315
	17	10	-	44 655 315	44 656 315
160	11	16	-	44 659 317	44 660 317
	17	10	-	44 655 317	44 656 317
180	11	16	-	44 659 318	44 660 318
	17	10	-	44 655 318	44 656 318

* The size is the nominal core pipe outside diameter.

Other diameters, SDRs and lengths can be made to order subject to a minimum order quantity.

Protecta-Line pipe



3^C - COILS

Size* (mm)	SDR	Pressure Rating (bar)	50M Code	75M Code	100M Code
63	11	16	44 845 311	-	44 860 311
90	11	16	44 845 313	44 862 313	44 860 313
	17	10	44 846 313	44 847 313	44 849 313
110	11	16	44 845 314	44 862 314	44 860 314
	17	10	44 846 314	44 847 314	44 849 314
125	11	16	44 845 315	44 862 315	44 860 315
	17	10	44 846 315	44 847 315	44 849 315
160	11	16	44 845 317	44 862 317	44 860 317
	17	10	44 846 317	44 847 317	44 849 317
180	11	16	44 845 318	44 862 318	44 860 318
	17	10	44 846 318	44 847 318	44 849 318



3^{CTH} - COILS

Size* (mm)	SDR	Pressure Rating (bar)	50M Code	75M Code	100M Code
63	11	16	44 850 311	-	44 852 311
90	11	16	44 850 313	44 851 313	44 852 313
	17	10	44 853 313	44 854 313	44 855 313
110	11	16	44 850 314	44 851 314	44 852 314
	17	10	44 853 314	44 854 314	44 855 314
125	11	16	44 850 315	44 851 315	44 852 315
	17	10	44 853 315	44 854 315	44 855 315
160	11	16	44 850 317	44 851 317	44 852 317
	17	10	44 853 317	44 854 317	44 855 317
180	11	16	44 850 318	44 851 318	44 852 318
	17	10	44 853 318	44 854 318	44 855 318

Protecta-Line mechanical compression fittings

PROTECTA-LINE TO PROTECTA-LINE COUPLER

Size (mm)	Product Code
25 x 25	44 100 307
32 x 32	44 100 308
63 x 63	44 100 311



PROTECTA-LINE TO PROTECTA-LINE REDUCING COUPLER

Size (mm)	Product Code
32 x 25	44 114 409
63 x 25	44 114 412
63 x 32	44 114 415



PROTECTA-LINE TO COPPER COUPLER

Size (mm)	Product Code
25 x 15	44 996 005
25 x 22	44 996 006
32 x 28	44 996 007



EQUAL TEE

Size (mm)	Product Code
25 x 25	44 122 307
32 x 32	44 122 308
63 x 63	44 122 311



Protecta-Line mechanical compression fittings

90° ELBOWS

Size (mm)	Product Code
25	44 115 307
32	44 115 308
63	44 115 311



END CONNECTORS - PROTECTA-LINE x Male Iron BSP Tapered

Size (mm x inch)	Product Code
25 x 3/4	44 151 608
32 x 3/4	44 151 611
32 x 1	44 151 612
63 x 1 1/2	44 151 628
63 x 2	44 151 629



END CONNECTORS - PROTECTA-LINE x Female Iron BSP Tapered

Size (mm x inch)	Product Code
25 x 3/4	44 101 608
32 x 1	44 101 612
63 x 2	44 101 629



Protecta-Line mechanical compression fittings

90° ELBOWS - PROTECTA-LINE x Female Iron BSP Tapered

Size (mm x inch)	Product Code
25 x 3/4	44 396 608
32 x 1	44 396 612
63 x 2	44 396 629



REDUCING SETS - to allow easy Protecta-Line diameter changes

Size (mm)	Product Code
32 x 25	44 105 409
63 x 32	44 105 415



STOP COCKS - BS 5433 Type

Size (mm)	Product Code
25*	44 142 307
32**	44 142 308

- * Includes 22mm copper Type A insert
- ** Includes 28mm copper Type A insert



Protecta-Line electrofusion fittings

COUPLERS - Removable Centre Stop

Size (mm)	SDR11 Code
90	PF 612 687
110	PF 612 688
125	PF 612 689
160	PF 612 691



COUPLERS - Slideover

Size (mm)	SDR11 Code
180	PF 612 672
225	PF 612 674
250	PF 612 675
280	PF 615 073
315	PF 612 670
355	PF 615 074



Couplers are available up to 630mm, please contact our customer service team for more information

REDUCERS

Size (mm)	SDR11 Code
110 x 90	PF 615 693
125 x 90	PF 615 694
125 x 110	PL 402 493
160 x 110	PF 615 695
180 x 125	PL 402 505



Protecta-Line electrofusion fittings

EQUAL TEES

Size (mm)	SDR11 Code
90	PF 612 166
110	PF 612 167
125	PF 612 168
160	PF 615 277
180	PF 615 691



90° ELBOWS

Size (mm)	SDR11 Code
90	PF 612 103
110	PF 612 105
125	PF 612 107
160	PF 615 276
180	PF 615 689



45° ELBOWS

Size (mm)	SDR11 Code
90	PF 612 102
110	PF 612 104
125	PF 612 106
160	PF 615 275
180	PF 615 687



Protecta-Line electrofusion fittings

FLANGED TEES

Size (mm)	SDR11 Code
90 x 80 PN16	PF 301 313
110 x 80 PN16	PF 301 314
125 x 80 PN16	PF 301 315
160 x 80 PN16	PF 301 317
180 x 80 PN16	PF 301 318
90 x 100 PN16	PF 302 313
110 x 100 PN16	PF 302 314
125 x 100 PN16	PF 302 315
160 x 100 PN16	PF 302 317
180 x 100 PN16	PF 302 318
160 x 150 PN16	PF 303 317
180 x 150 PN16	PF 303 318



Supplied factory-wrapped to ensure complete barrier performance.

Protecta-Line electrofusion fittings

FLANGE ADAPTOR KIT

Size (mm)	SDR11	Product Code
90 x 80	11	PF 251 313
110 x 100	11	PF 251 314
125 x 100	17	PF 250 315
160 x 150	17	PF 250 317
180 x 150	17	PF 250 318
225 x 200	17	PF 250 320



Adaptor Kit comprises of:-

- 1 x Stub Flange
- 1 X Coupler
- 1 x Gasket
- 1 x Backing Ring

Protecta-Line fabricated fittings

REDUCERS

Size (mm)	Code SDR11	Code SDR17
110 x 90	44 323 483	44 322 483
125 x 90	44 323 484	44 322 484
160 x 90	44 323 486	44 322 486
160 x 110	44 323 495	44 322 495
160 x 125	44 323 504	44 322 504
180 x 90	44 323 487	44 322 487
180 x 125	44 323 505	44 322 505
225 x 160	44 323 507	44 322 507
250 x 125	44 323 508	44 322 508
250 x 180	44 323 529	44 322 529
315 x 180	44 323 531	44 322 531
315 x 250	44 323 543	44 322 543
355 x 180	44 323 532	44 322 532
355 x 250	44 323 544	44 322 544
355 x 315	44 323 547	44 322 547



EQUAL TEES

Size (mm)	Code SDR11	Code SDR17
90	44 321 313	44 320 313
110	44 321 314	44 320 314
125	44 321 315	44 320 315
160	44 321 317	44 320 317
180	44 321 318	44 320 318
225	44 321 320	44 320 320
250	44 321 321	44 320 321
280	44 321 322	44 320 322
315	44 321 323	44 320 323
355	44 321 324	44 320 324



*Protecta-line fabricated fittings are available up to 630mm, please contact our customer service team for more information

Protecta-Line fabricated fittings

STUB FLANGE ASSEMBLIES PN16

Size (mm)	Code SDR11	Code SDR17
90 x DN80	44 327 313	44 326 313
110 x DN100	44 327 314	44 326 314
125 x DN100	44 327 315	44 326 315
160 x DN150	44 327 317	44 326 317
180 x DN150	44 327 318	44 326 318
225 x DN200	44 327 320	44 326 320
250 x DN250	44 327 321	44 326 321
280 x DN250	44 327 322	44 326 322
315 x DN300	44 327 323	44 326 323
355 x DN350	44 327 324	44 326 324



SLIMFLANGE ASSEMBLIES

Size (mm)	Code SDR11	Code SDR17
250 x DN200	44 453 321	44 452 321
315 x DN250	44 453 323	44 452 323
355 x DN300	44 453 324	44 452 324



END CAPS

Size (mm)	Code SDR11	Code SDR17
90	44 332 313	44 331 313
110	44 332 314	44 331 314
125	44 332 315	44 331 315
160	44 332 317	44 331 317
180	44 332 318	44 331 318
225	44 332 320	44 331 320
250	44 332 321	44 331 321
280	44 332 322	44 331 322
315	44 332 323	44 331 323
355	44 332 324	44 331 324



Protecta-Line fabricated fittings

Protecta-Line fabricated fittings are available up to 630mm

FLANGED SHORT BRANCH TEES

Size (mm)	Code SDR11	Code SDR17
90 x DN80	44 341 313	44 310 313
110 x DN80	44 341 314	44 310 314
125 x DN80	44 341 315	44 310 315
160 x DN80	44 341 317	44 310 317
180 x DN80	44 341 318	44 310 318
225 x DN80	44 341 320	44 310 320
250 x DN80	44 341 321	44 310 321
280 x DN80	44 341 322	44 310 322
315 x DN80	44 341 323	44 310 323
355 x DN80	44 341 324	44 310 324
90 x DN100	44 342 313	44 311 313
110 x DN100	44 342 314	44 311 314
125 x DN100	44 342 315	44 311 315
160 x DN100	44 342 317	44 311 317
180x DN100	44 342 318	44 311 318
225 x DN100	44 342 320	44 311 320
250 x DN100	44 342 321	44 311 321
280 x DN100	44 342 322	44 311 322
315 x DN100	44 342 323	44 311 323
355 x DN100	44 342 324	44 311 324
160 x DN150	44 343 317	44 312 317
180 x DN150	44 343 318	44 312 318
225 x DN150	44 343 320	44 312 320
250 x DN150	44 343 321	44 312 321
280 x DN150	44 343 322	44 312 322
315 x DN150	44 343 323	44 312 323
355 x DN150	44 343 324	44 312 324



Protecta-Line fabricated fittings

Protecta-Line fabricated fittings are available up to 630mm

REDUCED BRANCH TEE

Size (mm)	Code SDR11	Code SDR17	
90mm branch	110	44 347 314	44 356 314
	125	44 347 315	44 356 315
	160	44 347 317	44 356 317
	180	44 347 318	44 356 318
	225	44 347 320	44 356 320
	250	44 347 321	44 356 321
125mm branch	280	44 347 322	44 356 322
	315	44 347 323	44 356 323
	355	44 347 324	44 356 324
	180	44 348 318	44 357 318
	225	44 348 320	44 357 320
	250	44 348 321	44 357 321
180mm branch	280	44 348 322	44 357 322
	315	44 348 323	44 357 323
	355	44 348 324	44 357 324
	225	44 349 320	44 358 320
	250	44 349 321	44 358 321
	280	44 349 322	44 358 322
250mm branch	315	44 349 323	44 358 323
	355	44 349 324	44 358 324
	315	44 335 323	44 336 323
	355	44 335 324	44 336 324



Protecta-Line fabricated fittings

Protecta-Line fabricated fittings are available up to 630mm

90° MITRED ELBOW

Size (mm)	Code SDR11	Code SDR17
90	44 244 313	44 243 313
110	44 244 314	44 243 314
125	44 244 315	44 243 315
160	44 244 317	44 243 317
180	44 244 318	44 243 318
225	44 244 320	44 243 320
250	44 244 321	44 243 321
280	44 244 322	44 243 322
315	44 244 323	44 243 323
355	44 244 324	44 243 324



45° MITRED ELBOW

Size (mm)	Code SDR11	Code SDR17
90	44 242 313	44 241 313
110	44 242 314	44 241 314
125	44 242 315	44 241 315
160	44 242 317	44 241 317
180	44 242 318	44 241 318
225	44 242 320	44 241 320
250	44 242 321	44 241 321
280	44 242 322	44 241 322
315	44 242 323	44 241 323
355	44 242 324	44 241 324



Protecta-Line fabricated fittings

Protecta-Line fabricated fittings are available up to 630mm

22.5° MITRED ELBOW

Size (mm)	Code SDR11	Code SDR17
90	44 317 313	44 316 313
110	44 317 314	44 316 314
125	44 317 315	44 316 315
160	44 317 317	44 316 317
180	44 317 318	44 316 318
225	44 317 320	44 316 320
250	44 317 321	44 316 321
280	44 317 322	44 316 322
315	44 317 323	44 316 323
355	44 317 324	44 316 324



11.25° MITRED ELBOW

Size (mm)	Code SDR11	Code SDR17
90	44 298 313	44 297 313
110	44 298 314	44 297 314
125	44 298 315	44 297 315
160	44 298 317	44 297 317
180	44 298 318	44 297 318
225	44 298 320	44 297 320
250	44 298 321	44 297 321
280	44 298 322	44 297 322
315	44 298 323	44 297 323
355	44 298 324	44 297 324



Protecta-Line Accessories

ALUMINIUM WRAPPING TAPE

Code	Description
44 996 008	Aluminium wrapping tape (45m long x 50mm wide)



SILICONE TAPE

Code	Description
53 996 001	Silicone tape (10.9m long x 48mm wide)



Protecta-Line mechanical fittings

COUPLERS

Size (mm)	SDR	Code
63	11	PTM109321
90	11	PTM109322
	17	PTM109324
110	11	PTM109326
	17	PTM109328
125	11	PTM109329
	17	PTM109330
160	11	PM 100 317
	17	PM 109 317
180	11	PM 100 318
	17	PM 109 318



Consists of 1 liner and 2 shells.

Protecta-Line mechanical fittings

REPAIR COUPLERS

Size (mm)	SDR	Code
63	11	PTM109371
90	11	PTM109372
	17	PTM109373
110	11	PTM109374
	17	PTM109375
125	11	PTM109377
	17	PTM109376
160	11	PM 246 317
	17	PM 245 317
180	11	PM 246 318
	17	PM 245 318



Consists of 1 liner and 2 shells.

REDUCERS

Size (mm)	SDR	Code
90 x 63	11	PTM109402
	17/11	PTM109403
110 x 90	11	PTM109404
	17	PTM109405
125 x 110	11	PTM109410
	17/11	PTM109406*
	17	PTM109407
160 x 125	11	PTM109411
	17	PTM109408
180 x 125	17	PTM109409



Consists of 1 x reducing liner and 2 x shells.

* 125mm SDR17 x 110mm SDR11

Protecta-Line mechanical fittings

90° ELBOWS

Size (mm)	SDR	Code
63	11	PTM109331
90	11	PTM109332
	17	PTM109333
110	11	PTM109334
	17	PTM109335
125	11	PTM109337
	17	PTM109336
160	11	PM 210 317
	17	PM 208 317
180	11	PM 210 318
	17	PM 208 318



Consists of 1 x elbow liner and 2 x shells.

45° ELBOWS

Size (mm)	SDR	Code
63	11	PTM109341
90	11	PTM109342
	17	PTM109343
110	11	PTM109344
	17	PTM109345
125	11	PTM109347
	17	PTM109346
160	11	PM 216 317
	17	PM 214 317
180	11	PM 216 318
	17	PM 214 318



Consists of 1 x elbow liner and 2 x shells.

Protecta-Line mechanical fittings

EQUAL TEES

Size (mm)	SDR	Code
63	11	PTM109351
90	11	PTM109352
	17	PTM109353
110	11	PTM109354
	17	PTM109355
125	11	PTM109357
	17	PTM109356
160	11	PM 222 317
	17	PM 220 317
180	11	PM 222 318
	17	PM 220 318



Consists of 1 x equal tee liner and 3 x shells.

STUB FLANGE ADAPTORS

Size (mm x mm)	SDR	Code	Flange Bolts	Flange Torque (Nm+/- 10%)
63 x DN50 PN16	11	PTM109361	M16 X 4	60
63 x DN80 PN16	11	PTM109362	M16 X 8	60
90 x DN80 PN16	11	PTM109363	M16 X 8	70
	17	PTM109364	M16 X 8	70
110 x DN100 PN16	11	PTM109366	M16 X 8	80
	17	PTM109367	M16 X 8	80
125 x DN100 PN16	11	PTM109369	M16 X 8	80
	17	PTM109368	M16 X 8	80
160 x DN150 PN16	11	PM 228 317	M20 X 8	120
	17	PM 226 317	M20 X 8	120
180 x DN150 PN16	11	PM 228 318	M20 X 8	120
	17	PM 226 318	M20 X 8	120
180 x DN150 PN16	17	PM 365 318	8 x M20	120



Consists of 1 x stub flange liner, 1 x shell and backing ring. The information given for bolting torque values are for metal to metal connections.

Flange bolts and gaskets are not included.
Drilled to BS EN 1092-1:2007.

Protecta-Line mechanical fittings

DUCK FOOT BENDS

Size (mm x PN)	SDR	Code	Flange Bolts	Flange Torque (Nm+/- 10%)
63 x DN80 PN16	11	PTM109391	M16 x 8	70
90 x DN80 PN16	11	PTM109392	M16 x 8	70
90 x DN80 PN16	17	PTM109393	M16 x 8	70
110 x DN80 PN16	11	PTM109394	M16 x 8	70
110 x DN80 PN16	17	PTM109395	M16 x 8	70
125 x DN80 PN16	17	PTM109396	M16 x 8	70
160 x DN80 PN16	17	PM 385 486	M16 x 8	70
180 x DN80 PN16	17	PM 385 487	M16 x 8	70



Consists of 1 x flanged bend, 1 x shell and gasket. Flange bolts and gaskets are not included.
Drilled to BS EN 1092-1:2007.

Protecta-Line ferrule off-takes

25MM AND 32MM SELF-TAPPING FERRULE OFF-TAKES

Size (mm)	Code	SDR
63 x 25	44 763 412	11
90-125 x 25	44 763 393	11*/17
160-180 x 25	44 763 397	11*/17
225 x 25	44 763 400	17**
250 x 25	44 763 401	17**
280 x 25	44 763 402	17**
315 x 25	44 763 403	11/17
355 x 25	44 763 404	11/17
63 x 32	44 763 415	11
90-125 x 32	44 763 417	11*/17
160-180 x 32	44 763 421	11*/17
225 x 32	44 763 424	17**
250 x 32	44 763 425	17**
280 x 32	44 763 426	17**
315 x 32	44 763 427	11/17
355 x 32	44 763 428	11/17



Protecta-Line ferrules are tested to a continuous operating pressure of 16 bar at 20°C.

* An additional cutter is required when ferrules are installed on SDR11 125mm and 180mm Protecta-Line pipe. For further information, please contact customer service on +44 1480 44 2600.

** SDR17 ferrules 225mm, 250mm and 280mm can be installed on SDR11 Protecta-Line pipe when a 25mm (product code: 44794005) or 32mm (product code: 44794006) pre-cutter is used to assist with cutting through SDR11 Protecta-Line pipe.

DUCTILE IRON FERRULE

Size (mm)	Code
25mm x 3/4" MI	44 762 407



PROTECTA-LINE PRE-CUTTERS (for use with 25mm and 32mm off-takes)

Size (mm)	Code
25mm	44 794 005
32mm	44 794 006



Protecta-Line ferrule off-takes

63MM FERRULE OFF-TAKES

Size (mm)	Code	SDR
90 x 63	44 763 459	11/17
110 x 63	44 763 460	11/17
125 x 63	44 763 461	11/17
160 x 63	44 763 463	11/17
180 x 63	44 763 464	11/17
225 x 63	44 763 466	11/17
250 x 63	44 763 467	11/17
280 x 63	44 763 468	11/17
315 x 63	44 763 469	11/17
355 x 63	44 763 470	11/17



Protecta-Line MI end connector is supplied with the ferrule

DRILL AND LINER TOOL HEADS (for use with 63mm Off-Takes)

Description	Code
Protecta-Line SS strap 2" drill head	44 794 008
Protecta-Line SS strap 2" liner insertion head	44 794 009
Protecta-Line SS strap 44mm cutter and liner insert kit	44 794 020
Protecta-Line drill/liner head o-ring kit	44 996 062



90° GUNMETAL ELBOW (optional, for use with 63mm Off-Takes)

Size	Code
2" MI x 2" FI	44 996 050



Protecta-Line boundary box



SERIES 3 COMPRESSION 25MM (1/4 TURN VALVE)

Part no.	Height		Lid	Tether	Base	Type
	Min (mm)	Max (mm)				
LUBA3020P	580	790	Water	None	Standard	No lid
LUBA3005P	580	790	Water	None	Standard	Round lid
LUBA3006P	640	850	Water	None	Standard	Slope adjusta
LUBA3007P	580	790	Water	None	Standard	Square cowl
LUBA3008P	640	850	Water	Tether	Standard	Surface box

SERIES 3 COMPRESSION 32MM (1/4 TURN VALVE)

Part no.	Height		Lid	Tether	Base	Type
	Min (mm)	Max (mm)				
LUBA3019P	580	790	Water	None	Standard	No lid
LUBA3015P	580	790	Water	None	Standard	Round lid
LUBA3016P	640	850	Water	None	Standard	Slope adjusta
LUBA3017P	580	790	Water	None	Standard	Square cowl
LUBA3018P	640	850	Water	Tether	Standard	Surface box

Protecta-Line boundary box



SERIES 3 PIPE TAILS 25MM (1/4 TURN VALVE)

Part no.	Height		Lid	Tether	Base	Type
	Min (mm)	Max (mm)				
LUBA3000P	580	790	Water	None	Standard	No lid
LUBA3001P	580	790	Water	None	Standard	Round lid
LUBA3002P	640	850	Water	None	Standard	Slope adjusta
LUBA3003P	580	790	Water	None	Standard	Square cowl
LUBA3004P	640	850	Water	Tether	Standard	Surface box

SERIES 3 PIPE TAILS 32MM (1/4 TURN VALVE)

Part no.	Height		Lid	Tether	Base	Type
	Min (mm)	Max (mm)				
LUBA3010P	580	790	Water	None	Standard	No lid
LUBA3011P	580	790	Water	None	Standard	Round lid
LUBA3012P	640	850	Water	None	Standard	Slope adjusta
LUBA3013P	580	790	Water	None	Standard	Square cowl
LUBA3014P	640	850	Water	Tether	Standard	Surface box

Protecta-Line boundary box



SERIES 1 PIPE TAILS 25MM (RISING SPINDLE TAP)

Part no.	Height		Lid	Tether	Base	Type
	Min (mm)	Max (mm)				
LUBA000P	580	790	Water	None	Standard	No lid
LUBA001P	580	790	Water	None	Standard	Round lid
LUBA002P	640	850	Water	None	Standard	Slope adjusta
LUBA003P	580	790	Water	None	Standard	Square cowl
LUBA004P	640	850	Water	Tether	Standard	Surface box



BRASS MANIFOLD BOX 3/4"

Part no.	Height		Lid	Tether	Base	Type
	Min (mm)	Max (mm)				
LUBA1068	580	790	Round lid	None	Standard	Female BSP
LUBA1075	640	850	Surface box	None	Standard	Female BSP

All lids come with a metal detection plate, keyhole and are marked 'Water' as standard

Protecta-Line boundary box accessories and spares

WATER LID WITH KEYHOLE & LOCATION PLATE

Part no.
LUBA0115



SQUARE FINISHING COWL

Part no.
LUBA1073



TETHERED SURFACE BOX INCLUDING WATER LID

Part no.
LUBA1036



SLOPE ADJUSTA UNIT

Part no.
LUBA0018



Protecta-Line boundary box accessories and spares

THERMAL INSULATION (FROST) PLUG 180MM, SERIES 1

Part no.
LUBM0123



THERMAL INSULATION (FROST) PLUG 180MM 1/4 TURN, SERIES 3

Part no.
LUQM0123



HEIGHT ADJUSTER TOOL

Part no.
LUBM0093



BOUNDARY BOX STOP TAP VALVE KEY

Part no.
LUBM1078



Meter carrier accessories and spares

1/4 TURN DOUBLE CHECK VALVE ASSEMBLY

Part no.
LUQA0001



PLUG AND O-RING KIT SHORT THREAD

Part no.
LUBA0037



PLUG AND O-RING KIT LONG THREAD

Part no.
LUBA0047



PLUG AND O-RING KIT NO FLOW

Part no.
LUBA0046



PLUG AND O-RING KIT TRICKLE FLOW

Part no.
LUBA0048



PROTECTA-LINE

Aliaxis UK
St Peters Road
Huntingdon
PE29 7DA
United Kingdom
T: +44 (0) 330 111 4233
orders@alixis.co.uk

alixis.co.uk/Protecta-Line

IG Protecta-Line V4 08.25

